

OMEGA[®] STRAIN GAGES

SPECIFICATIONS CHART

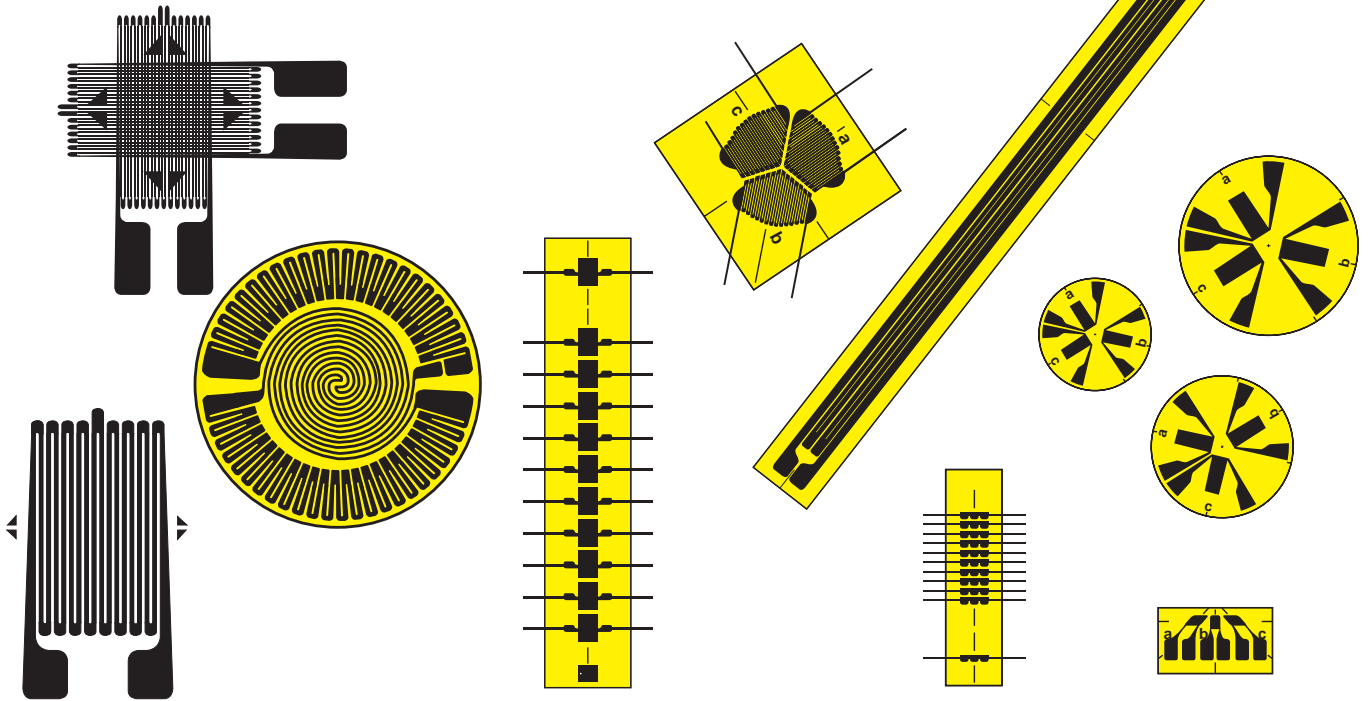

	SG SERIES	KFG SERIES
Foil strain gages are constructed by embedding a foil measuring element into a carrier. Foil measuring grid Carrier Substrate thickness Cover thickness Connection dimensions in (mm) [in]	Constantan foil 5 µm thick Polyimide 50 µm 25 µm Solder pads or ribbon leads (30 long x .05 thick x 3 wide) [1.2 long x .002 thick x .012 wide]	Constantan foil 6 µm thick Kapton 15 µm 9 µm 27 AWG strand polyvinyl insulation (1 x 2) [.04 x .08]
Nominal resistance Resistance tolerance per package Gage factor ($\mu\Omega/\mu\mu\Omega$) (actual value printed on each package) Gage factor tolerance per package	Stated in "to order" box 0.5% Approximately 2.0 1.0%	120 ±0.4 ohms 03% 2.10 ±10% 1.0%
Thermal Properties Reference temperature Service temperature: Static measurements Dynamic measurements Temperature characteristics: Steel Aluminum Uncompensated Temperature compensated range Tolerance of temp. compensation	23°C/73°F -30 to 250°C (-22 to 482°F) -30 to 300°C (-22 to 572°F) 11 ppm°C (6.1 ppm°F) 23 ppm°C (12.8 ppm°F) ±20 ppm°C (±11.1 ppm°F) -5 to 120°C (5 to 248°F) 1 ppm°C (0.5 ppm°F)	23°C/73°F -20 to 100°C (-4 to 212°F) -20 to 100°C (-4 to 212°F) 10.8 ppm°C (6 ppm°F) — 10 to 80°C (50 to 176°F) 1 ppm°C (0.5 ppm°F)
Mechanical Properties Maximum strain Hysteresis Fatigue (at ±1500 µε) Smallest bending radius Transverse sensitivity	3% or 30,000 µε Negligible > 10,000,000 cycles 3 mm (½ inch) —	5% or 50,000 µε Negligible > 10,000,000 cycles 3 mm (½ inch) Stated on each package

OMEGA® STRAIN GAGES

GENERAL PURPOSE STRAIN GAGES

FOR STATIC AND DYNAMIC APPLICATIONS

- ✓ Very Flexible, Mechanically Strong
- ✓ Small Bending Radius
- ✓ Broad Temperature Range
- ✓ Ribbon Leads, Solder Pads, or Wire Lead Connections
- ✓ Clear Alignment Marks
- ✓ Affix with Cold or Hot Curing Adhesives

Basic Unit
\$49

OMEGA® strain gages are available in a variety of different models to cover most strain measurement applications. Their rugged construction and flexibility make them suitable for static and dynamic measurement with a high degree of accuracy. The measuring grid is formed by etching Constantan foil, which is then completely sealed in a carrier medium composed of polyimide film.

MOST POPULAR MODELS

The most popular strain gage models are highlighted. Delivery of these models is normally off-the-shelf.

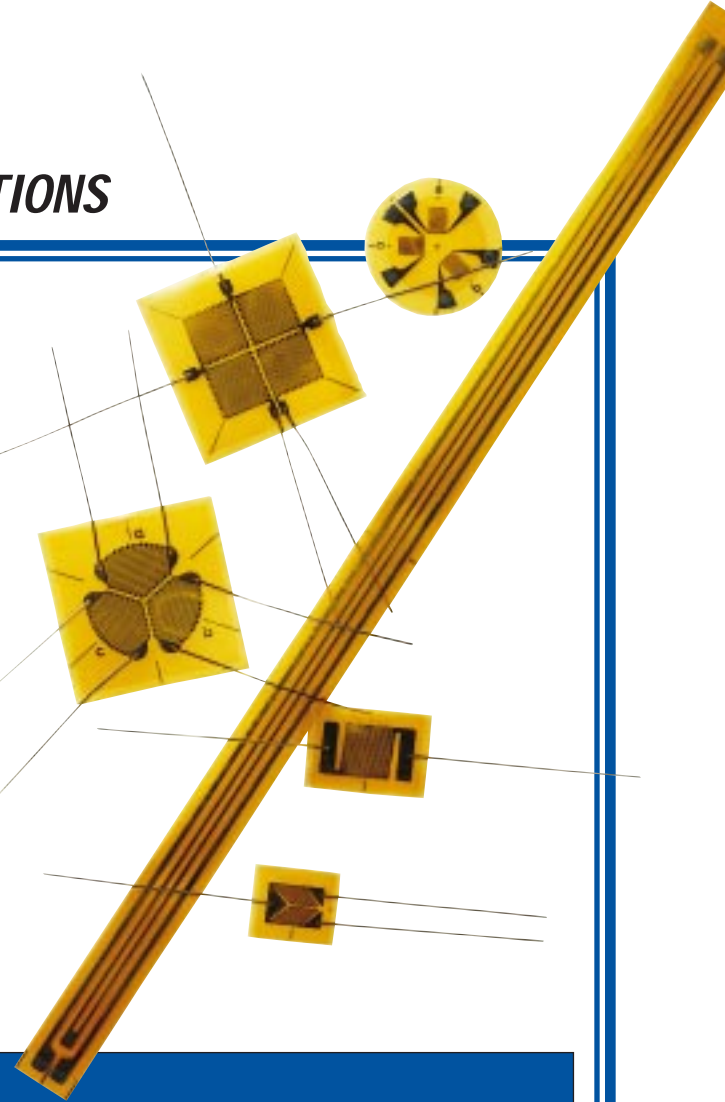

To Order (Specify Model Number)

TYPE SERIES	MODEL NO.	PRICE PER PKG OF 10	NOMINAL RESISTANCE (Ω)	DIMENSIONS [MM]				MAX PERMITTED BRIDGE ENERGIZING VOLTAGE (V RMS)	ACCESSORY TERMINAL PADS PART NO.	FIG.
				GRID A	GRID B	CARRIER C	CARRIER D			
✓ Encapsulated with Ribbon Leads (Accessory Terminal Pads Are Used to Attach Heavier Gage Wire to Ribbon Leads)	SG-1.5/120-LY11	\$49	120	1.5	1.1	4.8	3.5	2.5	TP-1	1
	SG-2/350-LY11	55	350	2.0	1.8	7.5	4.5	4	TP-1	2
	SG-3/120-LY11	55	120	3.0	1.5	8.0	4.0	4	TP-2	3
	SG-3/350-LY11	55	350	3.0	2.5	8.0	6.0	8	TP-2	3
	SG-6/120-LY11	70	120	6.0	3.0	12.5	6.0	9	TP-3	4
	SG-7/350-LY11	79	350	7.0	3.5	14.0	8.0	15	TP-3	4
	SG-7/1000-LY11	145	1000	7.0	3.8	12.0	6.0	20	TP-3	4
LY11 Temperature characteristics matched to steel	SG-13/1000-LY11	125	1000	13.5	5.5	24.0	12.0	30	TP-3	5
LY13 Temperature characteristics matched to aluminum	SG-1.5/120-LY13	49	120	1.5	1.1	4.8	3.5	3	TP-1	1
	SG-2/350-LY13	55	350	2.0	1.8	7.5	4.5	5	TP-1	2
	SG-3/120-LY13	55	120	3.0	1.5	8.0	4.0	6	TP-2	3
	SG-3/350-LY13	55	350	3.0	2.5	8.0	6.0	8	TP-2	3
	SG-6/120-LY13	70	120	6.0	3.0	12.5	6.0	10	TP-3	4
	SG-7/350-LY13	79	350	7.0	3.5	14.0	8.0	15	TP-3	4
	SG-7/1000-LY13	145	1000	7.0	3.8	12.0	6.0	20	TP-3	4
	SG-13/1000-LY13	125	1000	13.5	5.5	24.0	12.0	30	TP-3	5

LY11
Temperature characteristics matched to steel

LY13
Temperature characteristics matched to aluminum

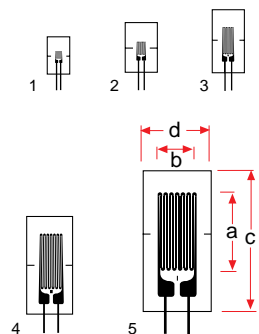

For Accessory Terminal Pads, see page E-25.

STRAIN GAGES E

OMEGA[®] STRAIN GAGES

FOIL GAGES

To Order (Specify Model Number)

TYPE SERIES Diagrams to Actual Size	MODEL NO.	PRICE PER PKG OF 10	NOMINAL RESISTANCE (Ω)	DIMENSIONS [MM]				MAX PERMITTED BRIDGE ENERGIZING VOLTAGE (V RMS)	ACCESSORY TERMINAL PADS PART NO.	FIG.
				GRID	CARRIER	A	B			
✓ Encapsulated with Solder Pads (Accessory Terminal Pads Are Used for Strain Relief and Connecting Different Wire Gages) LY41 Temperature characteristics matched to steel LY43 Temperature characteristics matched to aluminum	SG-1.5/120-LY41	\$45	120	1.5	1.1	4.8	3.5	2.5	TP-1	1
	SG-2/350-LY41	45	350	2.0	2.5	7.8	6.0	4	TP-1	2
	SG-3/120-LY41	49	120	3.0	1.5	8.0	4.0	4	TP-2	3
	SG-3/350-LY41	45	350	3.0	2.5	8.0	6.0	8	TP-2	3
	SG-6/120-LY41	62	120	6.0	3.0	12.5	6.0	9	TP-3	4
	SG-7/350-LY41	65	350	7.0	3.5	14.0	8.0	15	TP-3	4
	SG-7/1000-LY41	135	1000	7.0	3.8	12.0	6.0	20	TP-3	4
	SG-10/120-LY41	69	120	10.8	3.2	16.4	6.3	15	TP-3	5
	SG-13/1000-LY41	115	1000	13.5	5.5	24.0	12.0	30	TP-3	5
	SG-1.5/120-LY43	45	120	1.5	1.1	4.8	3.5	3	TP-1	1
	SG-2/350-LY43	45	350	2.0	2.5	7.8	6.0	5	TP-1	2
	SG-3/120-LY43	49	120	3.0	1.5	8.0	4.0	6	TP-2	3
	SG-3/350-LY43	45	350	3.0	2.5	8.0	6.0	8	TP-2	3
SG-6/120-LY43	62	120	6.0	3.0	12.5	6.0	10	TP-3	4	
SG-7/350-LY43	65	350	7.0	3.5	14.0	8.0	15	TP-3	4	
SG-7/1000-LY43	135	1000	7.0	3.8	12.0	6.0	20	TP-3	4	
SG-10/120-LY43	69	120	10.8	3.2	16.4	6.3	15	TP-3	5	
SG-13/1000-LY43	115	1000	113.5	5.5	24.0	12.0	30	TP-3		

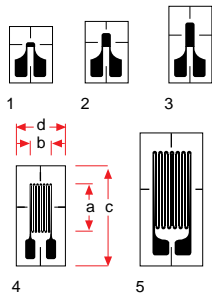

Typical Strain Gage Installation

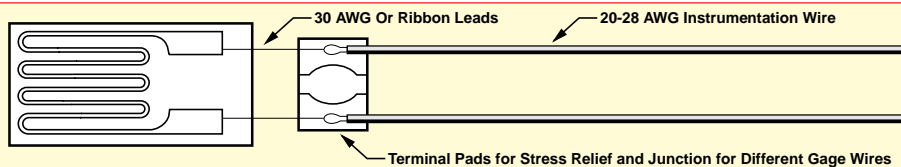

page E-25

To Order (Specify Model Number)

TYPE SERIES Diagrams to Actual Size	MODEL NO.	PRICE PER PKG OF 5	NOMINAL RESISTANCE (Ω)	DIMENSIONS [MM]				MAX PERMITTED BRIDGE ENERGIZING VOLTAGE (V RMS)	ACCESSORY TERMINAL PADS PART NO.	FIG.
				GRID	CARRIER	A	B			
✓ Extra Long Gages for Inhomogeneous Material	SG-30/120-LY40	\$105	120	24.5	8.0	41.0	13.0	20	TP-3	1
	SG-50/120-LY40	129	120	51.5	8.0	68.5	16.0	25	TP-3	2
	SG-150/240-LY40	135	240	153.0	3.5	167.0	10.0	35	TP-3	4

✓ Solder Pads, Not Encapsulated (Accessory Terminal Pads Are Used for Strain Relief and Connecting Different Gage Wires)

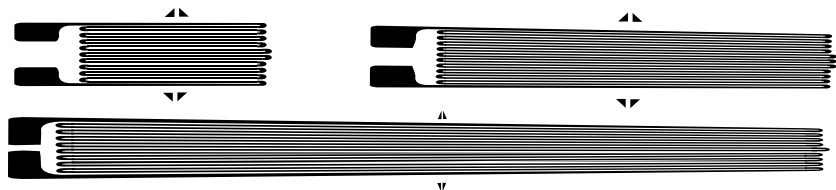

LY40

Temperature characteristics uncompensated



For Accessory Terminal Pads, see page E-25.

OMEGA® STRAIN GAGES

PRE-WIRED GAGES

To Order (Specify Model Number)

TYPE SERIES	MODEL NO.	PRICE PER PKG OF 10	NOMINAL RESISTANCE (Ω)	DIMENSIONS [MM]				MAX PERMITTED BRIDGE ENERGIZING VOLTAGE (V RMS)	FIG.
				GRID	CARRIER	A	B		
Encapsulated with 2 Lead Wires, 3 Feet Long, Attached	KFG-02-120-C1-11 L1 M2R	\$140	120	0.2	1.3	3.3	2.4	1	1
	KFG-1N-120-C1-11L1M2R	109	120	1.0	0.7	4.2	1.4	1.5	2
	KFG-2N-120-C1-11L1M2R	94	120	2.0	0.9	5.3	1.4	2	2
	KFG-3-120-C1-11L1M2R	88	120	3.0	1.3	7.4	2.8	4	3
	KFG-3-350-C1-11L1M2R	121	350	3.0	1.3	7.4	2.8	15	3
	KFG-5-120-C1-11L1M2R	80	120	5.0	1.4	9.4	2.8	8	3
	KFG-5-350-C1-11L1M2R	124	350	5.0	1.4	9.4	2.8	20	4
	KFG-10-120-C1-11L1M2R	100	120	10.0	3.0	16.0	5.2	15	4
	KFG-30-120-C1-11 L1M2R	119	120	30.0	3.3	37.0	5.2	25	5

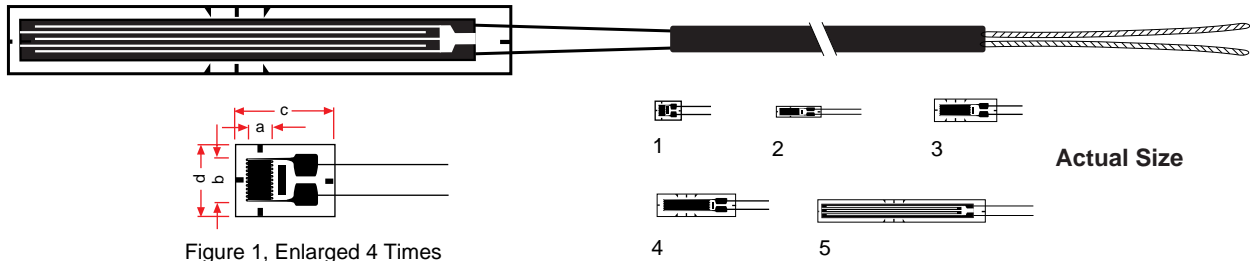

To Order (Specify Model Number)

TYPE SERIES	MODEL NO.	PRICE PER PKG OF 10	NOMINAL RESISTANCE (Ω)	DIMENSIONS [MM]				MAX PERMITTED BRIDGE ENERGIZING VOLTAGE (V RMS)	FIG.
				GRID	CARRIER	A	B		
Encapsulated with 3 Lead Wires, 9 Feet Long, Attached to Minimize Lead Wire Resistance Effects	KFG-02-120-C1-11L3M3R	\$184	120	1.0	1.3	3.3	2.4	1	1
	KFG-1N-120-C1-11L3M3R	153	120	1.0	0.7	4.2	1.4	1.5	2
	KFG-2N-120-C1-11L3M3R	138	120	2.0	0.9	5.3	1.4	2	2
	KFG-3-120-C1-11L3M3R	131	120	3.0	1.3	7.4	2.8	4	3
	KFG-3-350-C1-11L3M3R	165	350	3.0	1.3	7.4	2.8	15	3
	KFG-5-120-C1-11L3M3R	124	120	5.0	1.4	9.4	2.8	8	3
	KFG-5-350-C1-11L3M3R	165	350	5.0	1.4	9.4	2.8	20	4
	KFG-10-120-C1-11L3M3R	145	120	10.0	3.0	16.0	5.2	15	4
	KFG-30-120-C1-11L3M3R	163	120	30.0	3.3	37.0	5.2	25	5

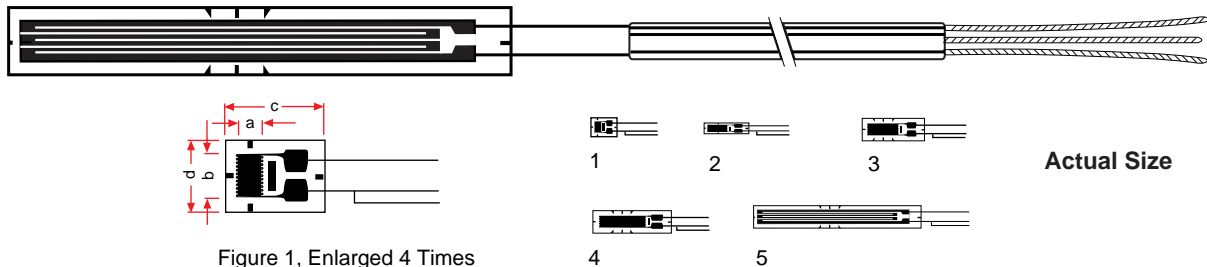

Ordering Example: KFG-02-120-C1-11L1M2R, package of ten pre-wired strain gages encapsulated with two lead wires attached, \$140

OMEGA® STRAIN GAGES

PERPENDICULAR GRIDS

FOR MEASURING AXIAL STRAIN

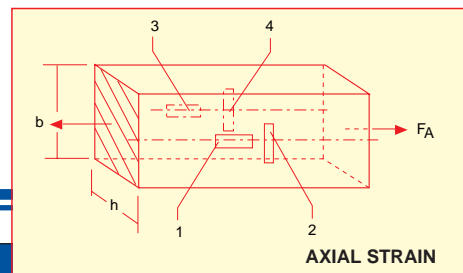

To Order (Specify Model Number)

TYPE SERIES	MODEL NO.	PRICE PER PKG OF 5	NOMINAL RESISTANCE (Ω)	DIMENSIONS [MM]				MAX PERMITTED BRIDGE ENERGIZING VOLTAGE (V RMS)	ACCESSORY TERMINAL PADS PART NO.	FIG.
				A	B	C	D			
✓ Encapsulated with Ribbon Leads XY11 Temperature characteristics matched to steel XY13 Temperature characteristics matched to aluminum	SG-2/120-XY11	\$115	120	2.4	1.2	6.3	5.0	5	TP-1	1
	SG-3/350-XY11	125	350	3.0	2.8	8.0	8.0	8	TP-2	1
	SG-7/350-XY11	155	350	7.0	3.5	13.0	13.0	15	TP-3	2
	SG-2/120-XY13	115	120	2.4	1.2	6.3	5.0	5	TP-1	1
	SG-3/350-XY13	125	350	3.0	2.8	8.0	8.0	8	TP-2	1
	SG-7/350-XY13	155	350	7.0	3.5	13.0	13.0	15	TP-3	2

Diagrams to Actual Size



For Accessory Terminal Pads, see page E-25.

✓ Encapsulated with Solder Pads XY41 Temperature characteristics matched to steel XY43 Temperature characteristics matched to aluminum	SG-2/120-XY41	\$115	120	2.4	1.2	6.3	5.05	5	TP-1	1
	SG-3/350-XY41	105	350	3.0	2.8	8.0	8.0	8	TP-2	1
	SG-7/350-XY41	149	350	7.0	3.5	13.0	13.0	15	TP-3	2
	SG-2/120-XY43	115	120	2.4	1.2	6.3	5.0	5	TP-1	1
	SG-3/350-XY43	105	350	3.0	2.8	8.0	8.0	8	TP-2	1
	SG-7/350-XY43	149	350	7.0	3.5	13.0	13.0	15	TP-3	2

Diagrams to Actual Size



For Accessory Terminal Pads, see page E-25.

TYPE SERIES	MODEL NO.	PRICE PER PKG OF 10	NOMINAL RESISTANCE (Ω)	DIMENSIONS [MM]				MAX PERMITTED BRIDGE ENERGIZING VOLTAGE (V RMS)	ACCESSORY TERMINAL PADS PART NO.	FIG.
				A	B	C	D			
✓ Encapsulated with 2 Lead Wires	KFG-1-120-D16-11L1M2S	\$274	120	1.0	1.2	5.0		1.5		1
	KFG-2-120-D16-11L1M2S	194	120	2.0	1.3	8.0		2		2
	KFG-3-120-D16-11L1M2S	194	120	3.0	1.3	10.0		4		3
	KFG-3-350-D16-11L1M2S	279	350	3.0	1.3	10.0		15		3
	KFG-5-120-D16-11L1M2S	194	120	5.0	1.4	11.0		8		4
	KFG-5-350-D16-11L1M2S	279	350	5.0	1.4	11.0		20		4

Diagrams to Actual Size

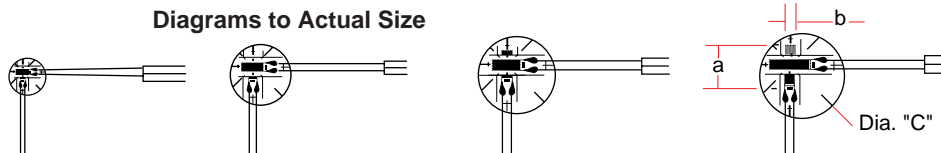

For Accessory Terminal Pads, see page E-25.

✓ Encapsulated with 3 Lead Wires	KFG-1-120-D16-11L3M3S	\$361	120	1.0	1.2	5.0		1.5		1
	KFG-2-120-D16-11L3M3S	281	120	2.0	1.3	8.0		2		2
	KFG-3-120-D16-11L3M3S	281	120	3.0	1.3	10.0		4		3
	KFG-5-120-D16-11L3M3S	281	120	5.0	1.4	11.0		8		4
	KFG-3-350-D16-11L3M3S	366	350	3.0	1.3	10.0		4		3
	KFG-5-350-D16-11L3M3S	366	350	5.0	1.4	11.0		8		4

Diagrams to Actual Size

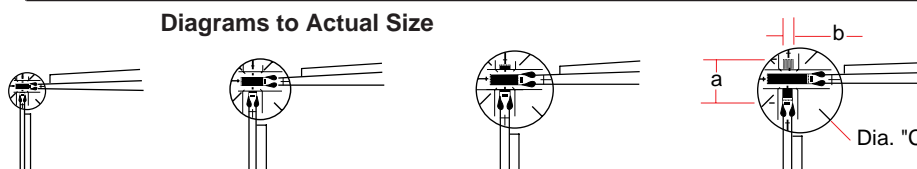

For Accessory Terminal Pads, see page E-25.

OMEGA® STRAIN GAGES

FOR MONITORING BENDING STRAINS

To Order (Specify Model Number)

TYPE SERIES	MODEL NO.	PRICE PER PKG OF 5	NOMINAL RESISTANCE (Ω)	DIMENSIONS [MM]				MAX PERMITTED BRIDGE ENERGIZING VOLTAGE (V RMS)	ACCESSORY TERMINAL PADS PART NO.	FIG.
				A	B	C	D			
✓ Encapsulated with Ribbon Leads DY11 Temperature characteristics matched to steel DY13 Temperature characteristics matched to aluminum	SG-2/1000-DY11	\$65	1000	2.1	2.7	8.0	9.0	5	TP-2	1
	SG-3/1000-DY11	55	1000	3.0	3.0	9.0	9.0	10	TP-3	2
	SG-7/1000-DY11	69	1000	7.0	3.8	12.0	11.0	15	TP-3	3
	SG-7/350-DY11	49	350	7.0	3.8	12.0	11.0	15	TP-3	3
	SG-2/1000-DY13	65	1000	2.1	2.7	8.0	9.0	5	TP-2	1
	SG-3/1000-DY13	55	1000	3.0	3.0	9.0	9.0	10	TP-3	2
	SG-7/1000-DY13	69	1000	7.0	3.8	12.0	11.0	15	TP-3	3
	SG-7/350-DY13	49	350	7.0	3.8	12.0	11.0	15	TP-3	3

Diagrams to Actual Size



For Accessory Terminal Pads, see page E-25.

✓ Encapsulated with Solder Pads DY41 Temperature characteristics matched to steel DY43 Temperature characteristics matched to aluminum	SG-2/1000-DY41	\$59	1000	2.1	2.7	8.0	9.0	5	TP-2	1
	SG-3/1000-DY41	49	1000	3.0	3.0	9.0	9.0	10	TP-3	2
	SG-7/1000-DY41	59	1000	7.0	3.8	12.0	11.0	15	TP-3	3
	SG-7/350-DY41	49	350	7.0	3.8	12.0	11.0	15	TP-3	3
	SG-2/1000-DY43	59	1000	2.1	2.7	8.0	9.0	5	TP-2	1
	SG-3/1000-DY43	49	1000	3.0	3.0	9.0	9.0	10	TP-3	2
	SG-7/1000-DY43	59	1000	7.0	3.8	12.0	11.0	15	TP-3	3
	SG-7/350-DY43	49	350	7.0	3.8	12.0	11.0	15	TP-3	3

Diagrams to Actual Size



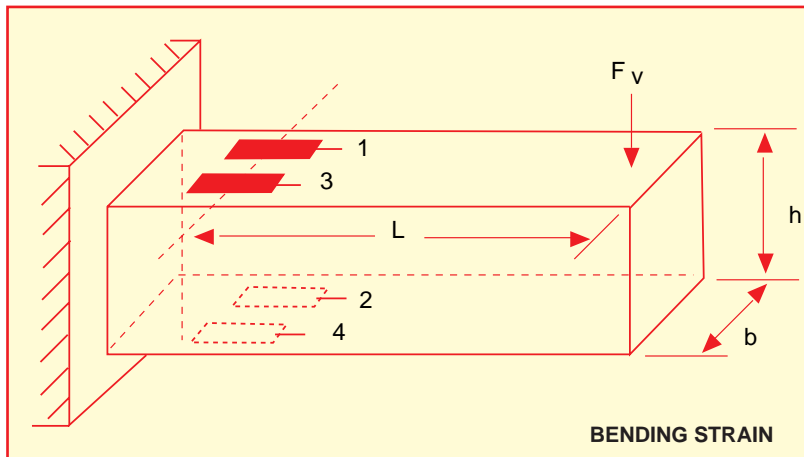

For Accessory Terminal Pads, see page E-25.

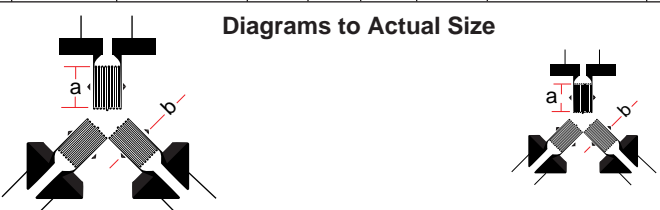
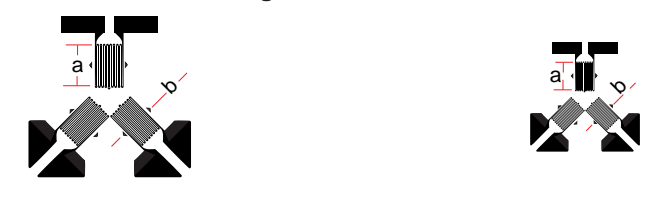

STRAIN GAGES ROSETTES

To Order (Specify Model Number)

TYPE SERIES	MODEL NO.	PRICE PER PKG OF 5	NOMINAL RESISTANCE (Ω)	DIMENSIONS [MM]				MAX PERMITTED BRIDGE ENERGIZING VOLTAGE (V RMS)	ACCESSORY TERMINAL PADS PART NO.	FIG.
				A	B	C	D			
0°/45°/90° Encapsulated with Ribbon Leads RY11 Temperature characteristics matched to steel RY13 Temperature characteristics matched to aluminum	SG-3/120-RY11	\$115	120	3.0	2.2	6.0	16.0	4	TP-3	1
	SG-3/350-RY11	139	350	3.0	2.2	16.0	16.0	8	TP-3	1
	SG-3/120-RY13	139	120	3.0	2.2	16.0	16.0	4	TP-3	1
Diagrams to Actual Size 										
For Accessory Terminal Pads, see page E-25.										
0°/45°/90° Encapsulated with Solder Pads RY31 Temperature characteristics matched to steel RY33 Temperature characteristics matched to aluminum	SG-3/120-RY31	\$129	120	3.0	2.2	16.0	16.0	4	TP-3	1
	SG-3/350-RY31	139	350	3.0	2.2	16.0	16.0	8	TP-3	1
	SG-3/120-RY33	129	120	3.0	2.2	16.0	16.0	4	TP-3	1
Diagrams to Actual Size 										
For Accessory Terminal Pads, see page E-25.										
0°/60°/120° Encapsulated with Ribbon Leads RY41 Temperature characteristics matched to steel RY43 Temperature characteristics matched to aluminum	SG-3/120-RY41	\$115	120	3.0	2.2	16.0	16.0	4	TP-3	1
	SG-3/350-RY41	129	350	3.0	2.2	16.0	16.0	8	TP-3	1
	SG-3/120-RY43	139	120	3.0	2.2	16.0	16.0	4	TP-3	1
Diagrams to Actual Size 										
For Accessory Terminal Pads, see page E-25.										
0°/60°/120° Encapsulated with Solder Pads RY71 Temperature characteristics matched to steel RY73 Temperature characteristics matched to aluminum	SG-3/120-RY71	\$109	120	3.0	2.2	16.0	16.0	4	TP-3	1
	SG-3/350-RY71	129	350	3.0	2.2	16.0	16.0	8	TP-3	1
	SG-3/120-RY73	109	120	3.0	2.2	16.0	16.0	4	TP-3	1
Diagrams to Actual Size 										
For Accessory Terminal Pads, see page E-25.										

OMEGA® STRAIN GAGES

PRE-WIRED ROSETTES

Rosettes are used to compute the state of stress at a particular point. The results will plot out Mohr's circle, which gives value and orientation of principal strains.

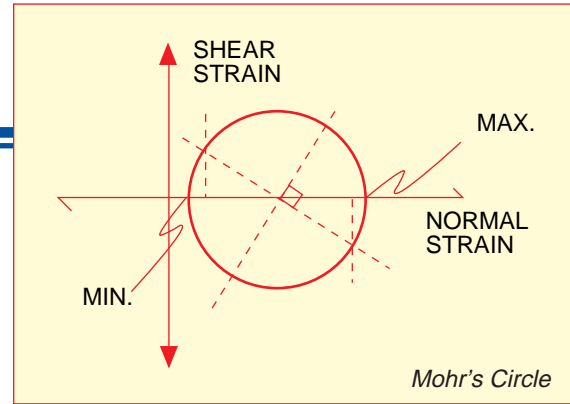

To Order (Specify Model Number)

TYPE SERIES	MODEL NO.	PRICE PER PKG OF 10	NOMINAL RESISTANCE (Ω)	DIMENSIONS [MM]			MAX PERMITTED BRIDGE ENERGIZING VOLTAGE (V RMS)	FIG.
				GRID	CARRIER			
				A	B	C		
✓ 0°/45°/90° Encapsulated with 2 Lead Wires (3 Feet Long) Attached to Each Element Temperature characteristics matched to steel	KFG-1-120-D17-11L1M2S	\$389	120	1.0	1.2	5.0	1.5	1
	KFG-2-120-D17-11L1M2S	286	120	2.0	1.3	8.0	2	2
	KFG-3-120-D17-11L1M2S	286	120	3.0	1.3	10.0	4	3
	KFG-3-350-D17-11L1M2S	419	350	3.0	1.3	10.0	15	3
	KFG-5-120-D17-11L1M2S	286	120	5.0	1.4	11.0	8	4
	KFG-5-350-D17-11L1M2S	419	350	5.0	1.4	11.0	20	4

Diagrams to Actual Size

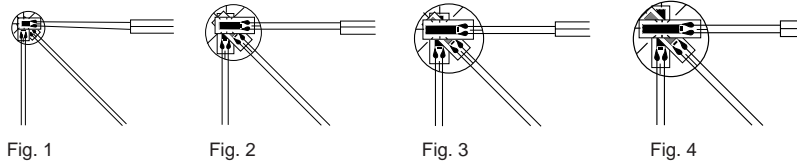

To Order (Specify Model Number)

TYPE SERIES	MODEL NO.	PRICE PER PKG OF 10	NOMINAL RESISTANCE (Ω)	DIMENSIONS [MM]			MAX PERMITTED BRIDGE ENERGIZING VOLTAGE (V RMS)	FIG.
				GRID	CARRIER			
				A	B	C		
✓ 0°/45°/90° Encapsulated with 3 Lead Wires (9 Feet Long) Attached to Each Element Temperature characteristics matched to steel	KFG-1-120-D17-11L3M3S	\$523	120	1.0	1.2	5.0	1.5	1
	KFG-2-120-D17-11L3M3S	419	120	2.0	1.3	8.0	2	2
	KFG-3-120-D17-11L3M3S	419	120	3.0	1.3	10.0	4	3
	KFG-3-350-D17-11L3M3S	549	350	3.0	1.3	10.0	15	3
	KFG-5-120-D17-11L3M3S	419	120	5.0	1.4	11.0	8	4
	KFG-5-350-D17-11L3M3S	549	350	5.0	1.4	11.0 1	20	4

Diagrams to Actual Size

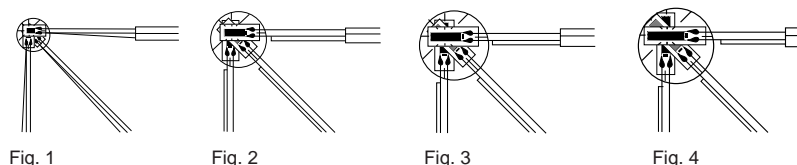

Ordering Example: KFG-2-120-D17-11L3M3S is a package of ten pre-wired rosette strain gages, encapsulated with three lead wires attached to each element, with temperature characteristics matched to steel, \$419.

OMEGA[®] STRAIN GAGES

CORNER ROSETTES AND STRESS RELIEF GAGES

To Order (Specify Model Number)

TYPE SERIES MODEL NO.	PRICE PER PKG OF 5	NOMINAL RESISTANCE (Ω)	DIMENSIONS [MM]				MAX PERMITTED BRIDGE ENERGIZING VOLTAGE (V RMS)	ACCESSORY TERMINAL PADS PART NO.	FIG.
			GRID A	GRID B	CARRIER C	CARRIER D			
SG-13/120-RY91	\$135	120	13.0	5.0	27.0	27.0	15	TP-3	1
SG-13/120-RY21	119	120	13.0	5.0	27.0	27.0	15	TP-3	2
SG-13/120-RY93	135	120	13.0	5.0	27.0	27.0	15	TP-3	1
SG-13/120-RY23	119	120	13.0	5.0	27.0	27.0	15	TP-3	2

✓ **Corner Rosette Encapsulated Gages**

Diagrams to Actual Size

RY91

Ribbon Leads - Temperature compensated to steel

RY21

Solder Pads - Temperature compensated to steel

RY93

Ribbon Leads - Temperature compensated to aluminum

RY23

Solder Pads - Temperature compensated to aluminum

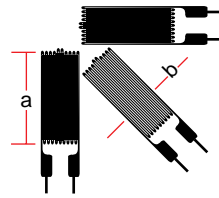

Fig. 1

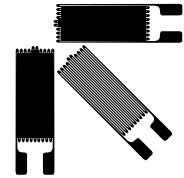
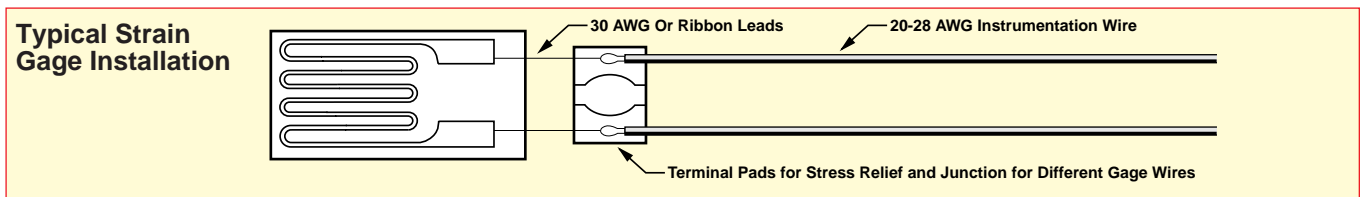

Fig. 2 (Enlarged)

For Accessory Terminal Pads, see page E-25.



To Order (Specify Model Number)

TYPE SERIES MODEL NO.	PRICE PER PKG OF 5	NOMINAL RESISTANCE (Ω)	DIMENSIONS [MM]				MAX PERMITTED BRIDGE ENERGIZING VOLTAGE (V RMS)	ACCESSORY TERMINAL PADS PART NO.	FIG.
			GRID A	GRID B	CARRIER C	CARRIER D			
SG-1.5/120-SR11	\$119	120	1.6	1.6	10.7	10.7	2.5	TP-2	1
SG-1.5/120-SR41	119	120	1.6	1.6	10.7	10.7	2.5	TP-2	2
SG-1.5/120-SR13	119	120	1.6	1.6	10.7	10.7	2.5	TP-2	1
SG-1.5/120-SR43	119	120	1.6	1.6	10.7	10.7	2.5	TP-2	2

✓ **Stress Relief Encapsulated Gages**

Diagram Fig.1 to Actual Size

Diagram Fig.2 Enlarged 2 Times

SR11

Ribbon Leads - Temperature compensated to steel

SR41

Solder Pads - Temperature compensated to steel

SR13

Ribbon Leads - Temperature compensated to aluminum

SR43

Solder Pads - Temperature compensated to aluminum

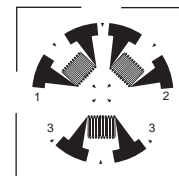
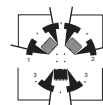

For Accessory Terminal Pads, see page E-25.

ROSETTE STRAIN GAGES

To Order (Specify Model Number)

TYPE SERIES	MODEL NO.	PRICE PER PKG OF 5	OHMS	DIMENSIONS [MM]				MAX EXC	TERM PADS	FIG
				GRID		CARRIER				
				A	B	C	D			
0°/45°/90° Encapsulated with Ribbon Leads RY51 Temperature characteristics matched to carbon steel RY53 Temperature characteristics matched to aluminum	SG-2/120-RY51	\$125	120	2.0	1.8	6.3	5.0	5	TP-1	1
	SG-3/350-RY51	139	350	3.0	1.6	7.0	6.8	8	TP-2	2
	SG-7/120-RY51	165	120	6.0	3.0	12.0	11.0	10	TP-3	3
	SG-2/120-RY53	125	120	2.0	1.8	6.3	5.0	5	TP-1	1
	SG-3/350-RY53	139	350	3.0	1.6	7.0	6.8	8	TP-2	2
	SG-7/120-RY53	165	120	6.0	3.0	12.0	11.0	10	TP-3	3

Diagrams Shown Larger Than Actual Size

For Accessory Terminal Pads, see page E-25.

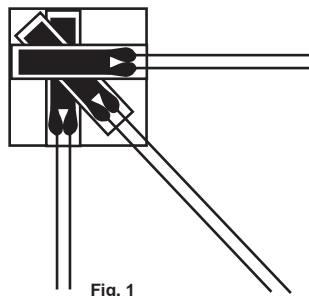

Fig. 1

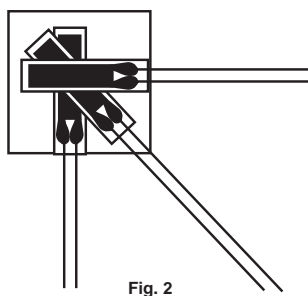

Fig. 2

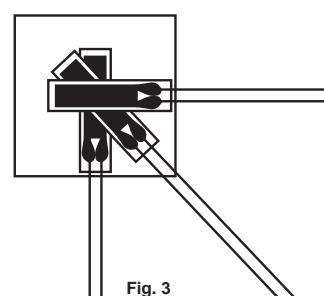

Fig. 3

To Order (Specify Model Number)

TYPE SERIES	MODEL NO.	PRICE PER PKG OF 5	OHMS	DIMENSIONS [MM]				MAX EXC	TERM PADS	FIG
				GRID		CARRIER				
				A	B	C	D			
0°/45°/90° Encapsulated with Solder Tabs RY61 Temperature characteristics matched to carbon steel RY63 Temperature characteristics matched to aluminum	SG-2/120-RY61	\$125	120	2.0	1.8	6.3	5.0	5	TP-1	1
	SG-3/350-RY61	139	350	3.0	1.6	7.0	6.8	8	TP-2	2
	SG-7/120-RY61	165	120	6.0	3.0	12.0	11.0	9	TP-3	3
	SG-2/120-RY63	125	120	2.0	1.8	6.3	5.0	5	TP-1	1
	SG-3/350-RY63	139	350	3.0	1.6	7.0	6.8	8	TP-2	2
	SG-7/120-RY63	165	120	6.0	3.0	12.0	11.0	9	TP-3	3

Diagrams Shown Larger Than Actual Size

For Accessory Terminal Pads, see page E-25.



Fig. 1



Fig. 2



Fig. 3

Ordering Example:
 SG-7/120-RY61, package of five rosette strain gages encapsulated with solder tabs, with temperature characteristics matched to carbon steel and max. excitation of 9 V, \$165.

OMEGA[®] STRAIN GAGES

CRACK AND DIAPHRAGM GAGES

Crack propagation gages are used to monitor crack growth. The gage is glued in place, and, as the crack grows under the gage, each of the limbs undergoes strain. The limbs are equally spaced, and when the limb undergoes 2% strain, it breaks. By monitoring the

continuity of each limb and the time when the limbs break, studies of the crack growth can be completed. The gages also incorporate a boundary limb, so that measuring equipment can be switched on when the crack reaches the gage area.

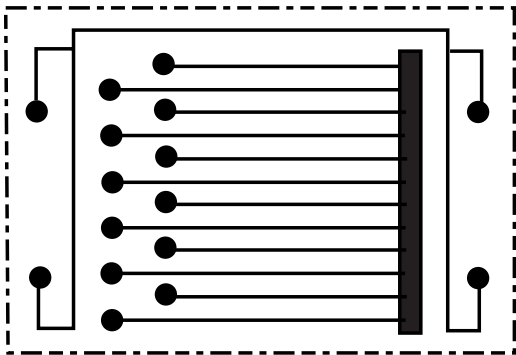
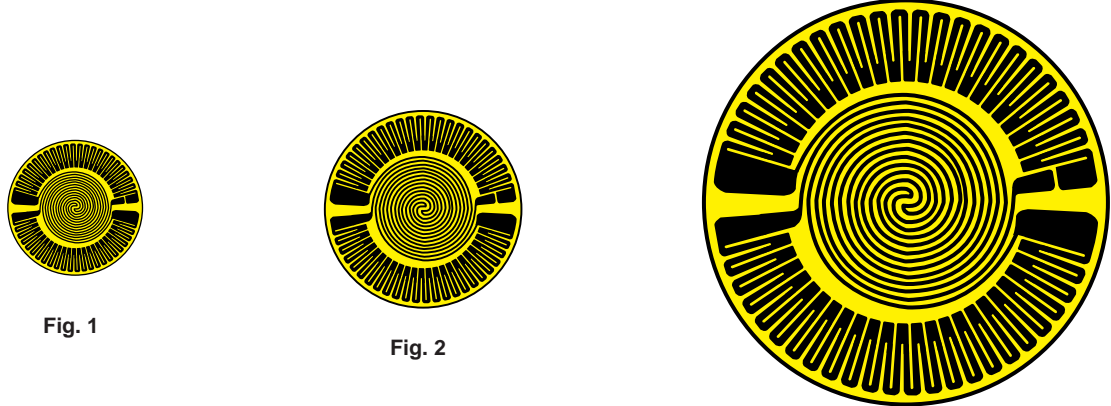
To Order (Specify Model Number)									
TYPE SERIES MODEL NO.	PRICE PER PKG OF 5	NOMINAL RESISTANCE (Ω)	DIMENSIONS [MM]				MAX PERMITTED BRIDGE ENERGIZING VOLTAGE (V RMS)	ACCESSORY TERMINAL PADS PART NO.	FIG.
			LIMBS		CARRIER				
			A	B	C	D			
SG-CP1	\$129	—	1.6	1.6	10.7	10.7	—	TP-2	2
<p>Crack Propagation Gage</p>  <p style="text-align: right;">Enlarged 4 Times</p>									
SG-13/200-DG11	\$165	200	Carrier Dia.:		13.2	10	TP-2	1	
SG-20/240-DG11	189	240	Carrier Dia.:		20	15	TP-2	2	
<p>Full Bridge Diaphragm Strain Gage</p> <p>✓ Encapsulated Diaphragm Gage with Ribbon Leads</p>  <p style="text-align: center;">Fig. 2 Enlarged 2 Times</p>									

TRANSDUCER-QUALITY STRAIN GAGES

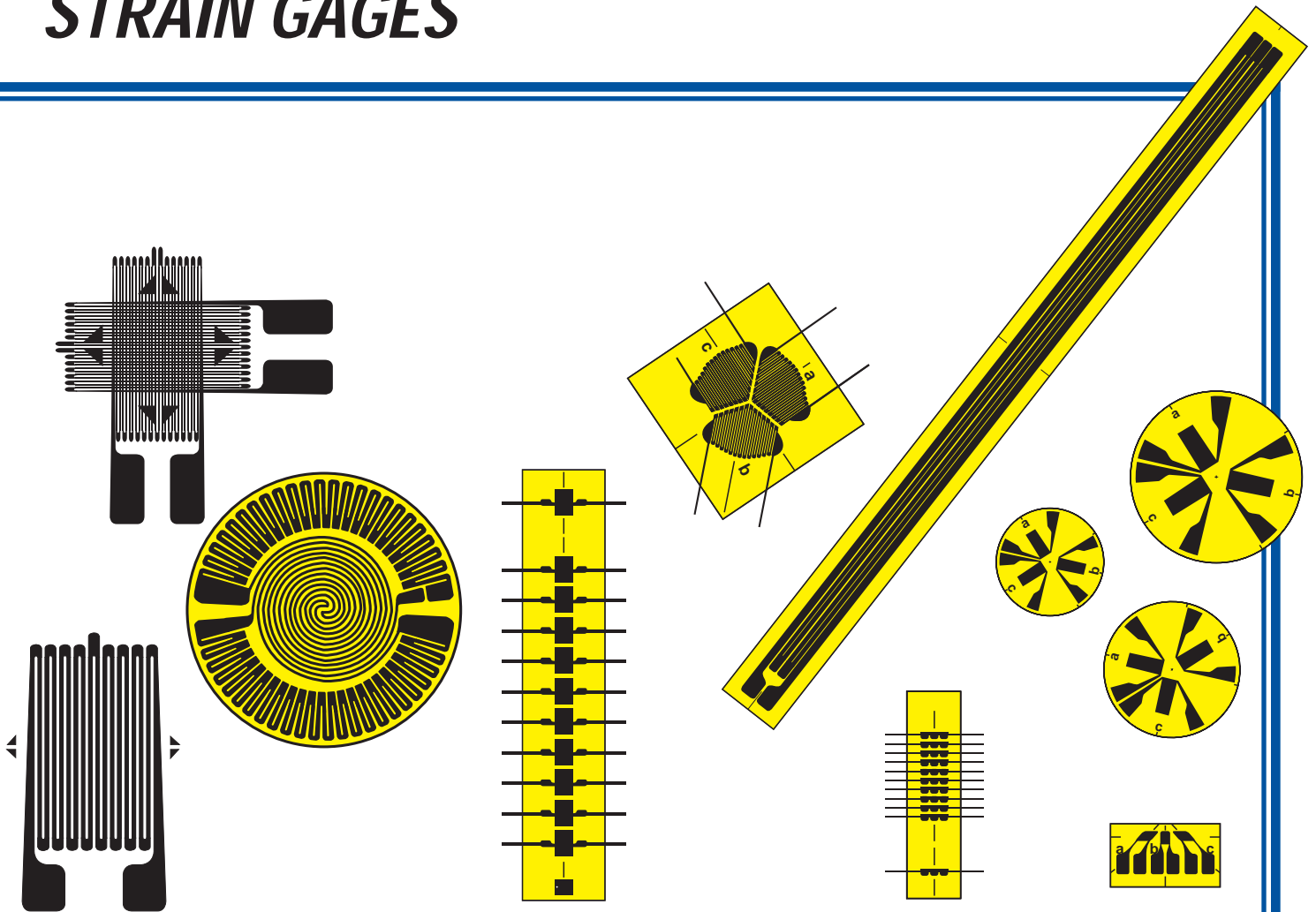

OMEGA's transducer-quality strain gages are high quality encapsulated foil strain gages which are available in many configurations. They are commonly used in transducer technology as well as in experimental analysis. The gages come in a variety of lengths, patterns, thermal expansion coefficients (matched to stainless steel, carbon steel, and aluminum), alloy materials and solder configurations. Resistors and resistor wire, used for zero temperature compensation, span temperature compensation, and zero balance, are also available for use with these gages.

SPECIFICATIONS

Foil Thickness: 5 μm
Carrier Material: Polyimide
Carrier Thickness: 50 μm
Connections: Solder pads (constantan gages); solder dots (karma)
Nominal Resistance: 350 and 1000 Ω
Resistance Tolerance: 0.5%
Gage Factor: 2.0 nominal (actual value printed on package)
Gage Factor Tolerance: 1.0%
Thermal Properties:
Reference Temp.: 23°C (73°F)
Service Temp.:
 Static: -30 to 250°C (-22 to 482°F)
 Dynamic: -30 to 300°C (-22 to 572°F)
Temperature Comp: (zero)
Carbon Steel (ferritic): +11 ppm/°C

Stainless Steel (austenitic): +17 ppm/°C
Aluminum: +23 ppm/°C
Compensated Temp.: -5 to 120°C (23 to 248°F)
Tolerance of Temp Comp.: 1 ppm/°C (0.5 ppm/°F)
Gage Factor Temp Coefficient:
 Constantan: 0.0090%/°C (+0.0050%/°F)
 Karma (SS comp): 0.0103%/°C (-0.0057%/°F)
Mechanical Properties:
Maximum Strain: 3% or 30,000 μS
Hysteresis: Negligible
Fatigue (@ 1,500 μS): >10,000,000 cycles
Smallest Bending Radius: 3 mm (0.12 inch)

TRANSDUCER-QUALITY STRAIN GAGES

To Order (Specify Model Number)

TYPE SERIES	MODEL NO.	PRICE PER PKG OF 5	FOIL MATERIAL	TEMP. COEF.*	DIMENSIONS [MM]				MAX EXC	TERM PADS		
					Ω	GRID A	GRID B	CARRIER C			CARRIER D	
LY SERIES UNIAXIAL GAGES ✓ Encapsulated Gages with Solder Pads (Accessory Terminal Pads Are Used for Strain Relief and Connecting Different Gage Wires)	SG-3/350-LY47K	\$89	Karma	SS	350	3.3	1.5	8.2	4.0	10	TP-2	
	SG-7/350-LY47K	95	Karma	SS	350	6.3	3.9	12	7.8	15	TP-3	
	SG-13/1000-LY47K	99	Karma	SS	1000	13.0	5.0	23	10	17	TP-3	
	SG-2/350-LY47	45	Constantan	SS	350	2.0	2.5	7.8	6.0	5	TP-1	
	SG-3/350-LY47	45	Constantan	SS	350	3.8	1.7	7.0	6.0	10	TP-2	
	SG-7/350-LY47	79	Constantan	SS	350	7.0	3.5	14.0	8.0	15	TP-3	
	SG-13/350-LY47	85	Constantan	SS	350	12.5	5.0	23.0	10.0	17	TP-3	
		Pkg of 10										
	SG-2/350-LY41	45	Constantan	CS	350	2.0	2.5	7.8	6.0	5	TP-1	
	SG-3/350-LY41	45	Constantan	CS	350	3.8	1.7	8.3	4.6	10	TP-2	
	SG-7/350-LY41	65	Constantan	CS	350	7.0	3.5	14.0	8.0	15	TP-3	
	SG-13/350-LY41	115	Constantan	CS	350	12.5	5.0	23.0	10.0	17	TP-3	
	SG-2/350-LY43	45	Constantan	ALUM	350	2.0	2.5	7.8	6.0	5	TP-1	
	SG-3/350-LY43	45	Constantan	ALUM	350	3.8	1.7	8.3	4.6	10	TP-2	
	SG-7/350-LY43	65	Constantan	ALUM	350	7.0	3.5	14.0	8.0	15	TP-3	
SG-13/350-LY43	115	Constantan	ALUM	350	12.5	5.0	23.0	10.0	17	TP-3		

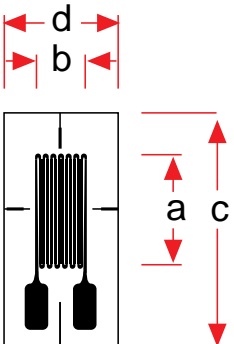

Diagram Shown Larger Than Actual Size

Dimensions

For Accessory Terminal Pads, see page E-25.

Ordering Example: SG-3/350-LY47K is a package of five uniaxial strain gages with Karma foil and encapsulated solder pads, \$89

* "SS" is a temperature coefficient matched to stainless steel. (LY47)
 "CS" is a temperature coefficient matched to carbon steel. (LY41)
 "ALUM" is a temperature coefficient matched to aluminum. (LY43)

To Order (Specify Model Number)

TYPE SERIES	MODEL NO.	PRICE PER PKG OF 5	FOIL MATERIAL	TEMP. COEF.*	DIMENSIONS [MM]				MAX EXC	TERM PADS	
					Ω	GRID A	GRID B	CARRIER C			CARRIER D
TY SERIES TORQUE GAGES ✓ Encapsulated Gages with Four Solder Pads (Accessory Terminal Pads Are Used for Strain Relief and Connecting Different Gage Wires)	SG-5/1000-TY47K	\$69	Karma	SS	1000	4.7	2.4	11.5	8.1	15	TP-2
	SG-6/1000-TY47K	45	Karma	SS	1000	5.7	3.8	11.5	8.6	15	TP-2
	SG-5/350-TY47	65	Constantan	SS	350	4.7	2.4	11.5	8.1	10	TP-2
	SG-6/350-TY47	35	Constantan	SS	350	5.7	3.8	11.5	8.6	10	TP-2
	SG-5/350-TY41	65	Constantan	CS	350	4.7	2.4	11.5	8.1	10	TP-2
	SG-6/350-TY41	35	Constantan	CS	350	5.7	3.8	11.5	8.6	10	TP-2
	SG-5/350-TY43	65	Constantan	ALUM	350	4.7	2.4	11.5	8.1	10	TP-2
	SG-6/350-TY43	35	Constantan	ALUM	350	5.7	3.8	11.5	8.6	10	TP-2

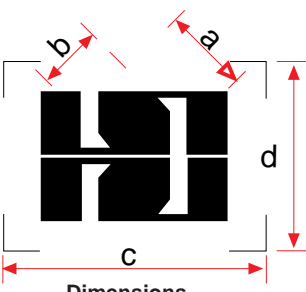

Diagram Shown Larger Than Actual Size

Dimensions

For Accessory Terminal Pads, see page E-25.

Ordering Example: SG-6/350-TY47 is a package of five torque gages with two Constantan grids, encapsulated with 4 solder pads, \$35.

* "SS" is a temperature coefficient matched to stainless steel. (TY47)
 "CS" is a temperature coefficient matched to carbon steel. (TY41)
 "ALUM" is a temperature coefficient matched to aluminum. (TY43)

Torsional Strain

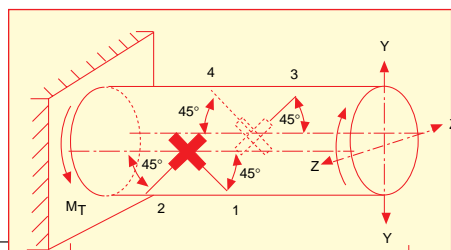

ROSETTE STRAIN GAGES

To Order (Specify Model Number)

TYPE SERIES	MODEL NO.	PRICE PER PKG OF 5	FOIL MATERIAL	TEMP. COEF.*	Ω	DIMENSIONS [MM]				MAX EXC	TERM PADS
						GRID		CARRIER			
						A	B	C	D		
Diagrams Shown Larger Than Actual Size	SG-4/1000-TY37K	\$49	Karma	SS	350	3.8	3.2	9.5	6.9	10	TP-2
	SG-4/350-TY37	45	Constantan	SS	350	3.8	3.2	9.5	6.9	10	TP-2
	SG-4/350-TY31	45	Constantan	CS	350	3.8	3.2	9.5	6.9	10	TP-2
	SG-4/350-TY33	45	Constantan	ALUM	350	3.8	3.2	9.5	6.9	10	TP-2

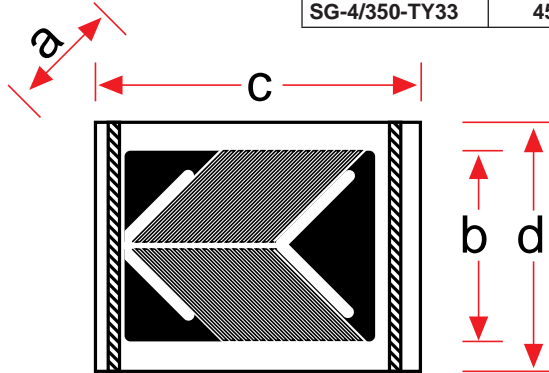

Dimensions

TY SERIES TORQUE GAGES

- ✓ Encapsulated Gages with Three Solder Pads (Accessory Terminal Pads Are Used for Strain Relief and Connecting Different Gage Wires)

Ordering Example: SG-4/1000-TY37K is a package of five torque gages with two Karma grids, encapsulated with three solder pads, \$49.
 * "SS" is a temperature coefficient matched to stainless steel. (TY37)
 * "CS" is a temperature coefficient matched to carbon steel. (TY31)
 * "ALUM" is a temperature coefficient matched to aluminum. (TY33)

For Accessory Terminal Pads, see page E-25.

To Order (Specify Model Number)

TYPE SERIES	MODEL NO.	PRICE PER PKG OF 5	FOIL MATERIAL	TEMP. COEF.*	Ω	DIMENSIONS [MM]				MAX EXC	TERM PADS
						GRID		CARRIER			
						A	B	C	D		
Diagram Shown Larger Than Actual Size	SG-3/350-XY47K	\$115	Karma	SS	350	3.0	2.8	8.0	8.0	10	TP-2
	SG-7/350-XY47K	149	Karma	SS	350	7.0	3.5	13.0	13.0	15	TP-3
	SG-3/350-XY47	109	Constantan	SS	350	3.0	2.8	8.0	8.0	10	TP-2
	SG-7/350-XY47	145	Constantan	SS	350	6.8	2.8	13.0	13.0	15	TP-3
	SG-3/350-XY41	105	Constantan	CS	350	3.0	2.8	8.0	8.0	10	TP-2
	SG-7/350-XY41	149	Constantan	CS	350	7.0	3.5	13.0	13.0	15	TP-3
	SG-3/350-XY43	105	Constantan	ALUM	350	3.0	2.8	8.0	8.0	10	TP-2
	SG-7/350-XY43	149	Constantan	ALUM	350	6.8	2.8	13.0	13.0	15	TP-3

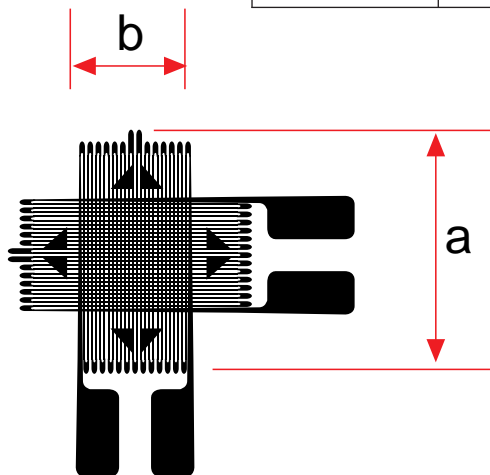

Dimensions

XY SERIES BIAxIAL GAGES FOR AXIAL STRAIN

- ✓ Encapsulated Gages with Solder Pads (Accessory Terminal Pads Are Used for Strain Relief and Connecting Different Gage Wires)

Ordering Example: SG-3/350-XY47K is a package of five biaxial gages with two Karma grids, encapsulated with solder pads, \$115.
 * "SS" is a temperature coefficient matched to stainless steel. (XY47)
 * "CS" is a temperature coefficient matched to carbon steel. (XY41)
 * "ALUM" is a temperature coefficient matched to aluminum. (XY43)

For Accessory Terminal Pads, see page E-25.